

OPERATING INSTRUCTIONS

nivcompTM

LEVELING INSTRUMENT

ELECTRONIC LEVEL

**Please read the Operating Instructions
before using for the first time**

Contents

- 01 Applications and measuring principle
- 02 Working range
- 03 The parts and their descriptions
- 04 Accessories (optional)
- 05 Symbols used
- 06 Leveling
- 07 Notes on handling
- 08 Indications for use
- 09 Swaying filter (in level measuring mode)
- 10 Height calibration / adjustments
- 11 Special displays
- 12 Renew battery
- 13 Notes on aftercare
- 14 Observe safety in the workplace
- 15 Function check
- 16 Malfunctions
- 17 Warranty / repair service
- 18 Disposal / protection of the environment
- 19 Ec declaration of conformity
- 20 Technical data



01

APPLICATIONS AND MEASURING PRINCIPLE

The primary applications are taking leveling and control measurement readings in interior construction work – for other applications please consult the Indications for Use. Gravimetric measuring is based on the pressure differential that builds up between the hand-held unit and the fluid reservoir.

02

WORKING RANGE

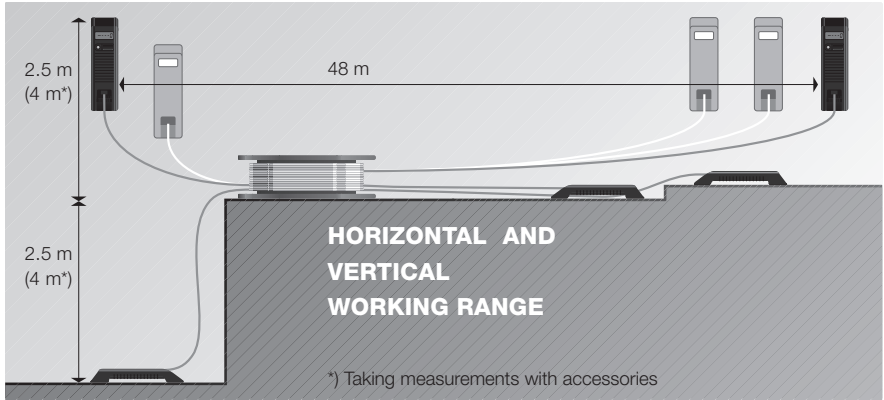

03

THE PARTS AND THEIR DESCRIPTIONS

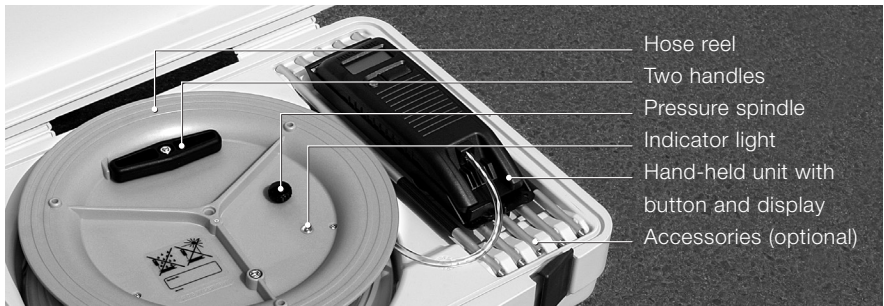

04



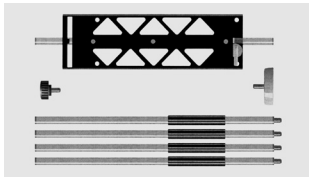





ACCESSORIES (OPTIONAL)



Consisting of holder for unit, 4 prods, magnetic clamp and protective cap. The accessories extend the range of vertical measurement. The prods are to be fitted to the top or bottom depending on the direction of measurement and should have the magnetic clamp or protective cap attached at the end.

SYMBOLS USED





05

-  Press button for a short time
- 2s**  Press button for about 2 seconds
- 5s**  Press button for about 5 seconds
- 2x**  Double click on button
-  **Always turn pressing screw in the direction of »measure« until the noticeable final position. (Indicator light flashes)** 
-  **Always turn pressing screw in the direction of »rest« until the noticeable final position. (Indicator light goes OFF)** 
-  Acoustic signal/sound

LEVELING







06

Preparing for leveling





- 1**  Put the case or reel in a stable position
- 2**  Reduce the system pressure 
- 3**  Let out enough hose allowing all measuring points to be reached without tension on the hose reel.







Measuring

Button	Display	
	on _ - - -	Start
	---- 0	Place against reference point and hold steady
	- n -	Save the reference level
	▲ 12 - 0	Check level between measuring points
	---- _ - - -	Return to start position
	OFF	Switch off

Additional functions

Button	Display	
5s 	5ELt	Settings (see Item 10)
		Hold
		Continue
2x 		Vibration filter on
		Vibration filter off

Terminating measuring mode

- 1**  Reel in the hose without twisting it
- 2**  Put the unit in the case
- 3**  Pressurize the system 





07

NOTES ON HANDLING

The selected lead edge on the reference level applies for all further measuring points. Vertical alignment may be judged by eye.

For aligning in poor light:

In a dark or concealed position, hold displays using  and then read off. To terminate holding:  or after 40 s.

LED flashing light:

Zero – regular flashing, too low – slow flashing, too high – rapid flashing.

08

INDICATIONS FOR USE

If the following indications are observed, nivcomp allows rapid and reliable level checking.



- ➔ **First check the position of the pressure spindle (see Item 5).**
- ➔ **Taking additional measurements for checking based on the reference level considerably improves measuring reliability.**

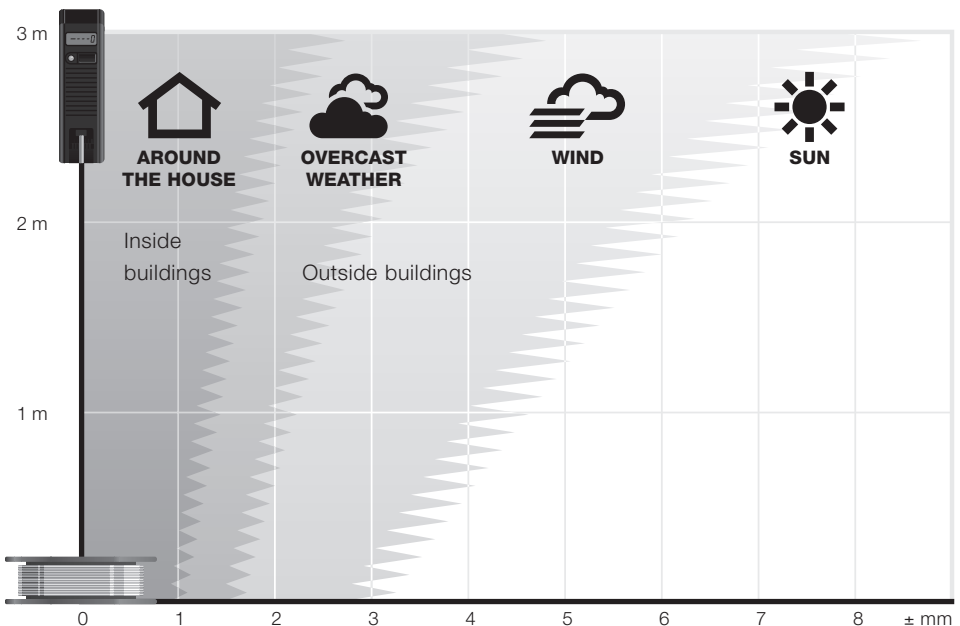

Illustration: Typical measurement reading scatter within hose radius as a function of thermal conditions and relative measuring height. For this reason no standard deviation is given.



- Lay the hose flat and do not let it sag.
- When measuring several points, do not do this cumulatively (risk of cumulative error!), but in a single level-measuring operation.
- In the case of a frequently used reference level, provide a permanent lay-on point (nail).
- When the °C symbol is displayed, the unit must be allowed to adjust to the ambient temperature for a few minutes, e.g. after being in transit or at extreme temperatures.
- Keep the outline or visual angle.
- Do not fling the hose (shock!).
- At low temperatures, avoid transmitting warmth from your hands to the hose.
- On wet surfaces, only measure with protective interlayer.

Measurements outdoors:

- Avoid intense or intermittent sunshine on unit components. A good time for level measurements outdoors is the early morning.
- Do not lay the hose over heated surfaces or expose to major changes in temperature (e.g. on exposed outdoor wall areas).

SWAYING FILTER (IN LEVEL MEASURING MODE)









09

Activate the swaying filter by double clicking **2x** ( symbol). When there is interference from swaying, a more lethargic response is sometimes beneficial. To deactivate filter: .

HEIGHT CALIBRATION / ADJUSTMENTS

10













On starting the unit, press the button until **SEtE** is displayed. The setting options will now follow each other in slow sequential order. After each operation, press the  button:

-  Correction of height display by +1 mm/meter for each press of the button.
-  Correction of height display by -1 mm/meter for each press of the button.
-   Direction or prefix display arrows or +/-
-   Height display selection in inches  or millimeters .
-  Set all settings to factory settings (Reset).

Height calibration should be checked once a year against a vertical tape measure.

SPECIAL DISPLAYS

11

-  Battery has power in reserve for another 20...50 hours.
-   Warning (flashing) battery discharged (from ~20 hours of reserve power).
-   Critical temperature change
-   Measurement range exceeded
-   1/2 an hour after a button is pressed an acoustic signal signals switch-off. To extend time: .
-   Hose reel warning hooter activated: Set screw has not been in the »store« position for a long time!

 Please note: After 2 hours of continuous operation the indicator light on the pressure spindle flashes at longer intervals, and after 6 hours it switches into sleep mode with memory function. To reactivate, turn the pressure spindle into the »store« position, wait for about 1/2 minute and turn back into the »measure« position.

**In case of unknown position of pressing screw, pull rotating head:
mobile = measurement point!**

12

RENEW BATTERY





The battery compartment may be opened using a coin against the head of the hand-held unit. The used battery must be disposed off in the regional recycling system.

The battery for the indicator light of the pressure spindle must be renewed after about 10 years. For this, completely flush out the hose, turn the pressure spindle into the »measure« position, loosen 6 screws on the reel casing (do not unscrew the handles) and withdraw the lower reel section upwards. After changing the battery, ensure that the reel casing sections click together properly again. Only tighten the 6 screws with light pressure.

13

NOTES ON AFTERCARE

- 1 After level measuring, always put the unit back in its case.
- 2 Always keep the unit in a clean, dry place once you have cleaned it.
- 3 Only use solvent-free cleaning agents.

  **If the unit is not to be used for a long period** set the pressure spindle to the »store« position.

14

OBSERVE SAFETY IN THE WORKPLACE

- 1 Do not run the hose at a height off the floor (trip hazard and risk of catching in vehicles).
- 2 Always top off the accessory prod extension with the protective cap!
- 3 Do not use the magnetic clamp above head height!

15

FUNCTION CHECK

1 Measurement reading stability (temperature-stabilized):

When placed on the reference level for several minutes the deviation should not exceed 1.

2 Pressurization:

Put the hand-held unit down and save the position as the reference level. Then turn the pressure spindle to the limit of the »store« setting. The value displayed should be in the range 600...1800.

→ **Unit does not start or suddenly switches off?**

→ Check battery and battery contacts.

→ **Unit switches off with the battery symbol flashin'?**

→ Renew the battery.

→ **Indicator light of the pressure spindle does not flash?**

→ See also special displays. Flashing is only weak: Renew the battery.

→ **Increased deviations on taking level measurement readings?**

Have you checked the pressure spindle and °C symbol?

Have you followed the notes on »Measuring outdoors«?

Are there airlocks in the hose or sensor area?

→ Bleeding by our technical service.

Air bubbles can arise if the pressure spindle has been left for several days in the »measure« position as well as due to overheating or shock.

→ **Damp or condensed water in the case?**

→ If there is damp in the hand-held unit, it must be removed from the battery and only replaced after being dried. Open the unit and the case and dry them.

→ **Leak in the hose system?**

→ The special hose can withstand high levels of mechanical stress (abrasion and crushing). If system fluid does leak out (non-poisonous and oily), soak this up using suitable means and dispose of in line with the regulations relating to waste oil.

Repair by our technical service.



Distribution and service is via reputable specialist dealers. Repairs are performed free of charge within the warranty period, provided the defect is due to identifiable faults in material or manufacture.

The unit must be sent to the supplier in a clean condition. A description of the fault or defect must be included. Current service addresses may be found at

www.dirotec.com

In line with EU directive 2002/96/EC (WEEE), at the end of its useful life, the user is obliged to return this leveling instrument to the manufacturer for waste utilization or environmentally friendly disposal.

EC DECLARATION OF CONFORMITY

We hereby declare, as the exclusive responsible party, that, on the basis of its design and construction, the nivcomp electronic hydrostatic level conforms with the relevant basic health and safety requirements of the EC directives.

Relevant EC directives: EC Directive on Electromagnetic Compatibility/Directive 89 /336 / ECC, 92 /31 /ECC (EN61326 + A1 /A2 /A3, EN61000-6-1, EN61000-6-3 + A11)

Dirotec Dietzsch & Rothe MSR-Technik OHG
Olzmannstraße 47 / D-08060 Zwickau
www.dirotec.com

TECHNICAL DATA

Measuring principle	Analog with digital display
Reproducibility (indoors, typical)	± 2 mm
At maximum measuring point distance	48 m
Vertical working range	± 2.5 m (± 4.0 m)
Height display	mm / inch
Resolution	1 mm (prefixes 0.3 mm)
Approx. temperature range for use	0 ... +35 °C
Battery for hand-held unit	1 x AA (alkaline) 1.5 V
Power required / On-time	~ 10 mW / ≥ 250 h
Automatic switch-off	33 min. after pressing a button
Flashing indicator	3V / Li (Lifetime ~ 10 y)
Shock resistance	ca. 1 m impact height
Transport and storage	-10 ... + 40 °C / -30 ... +55 °C
Dimensions	450 x 420 x 150 mm
Weight	Approx. 5.5 kg
Certification	CE FC RoHS compliant
Low emissions	In line with EMC product standard